



SBR II SmartBob Remote Unit



**INSTALLATION AND OPERATING INSTRUCTIONS
PLEASE READ CAREFULLY**







TABLE OF CONTENTS

SPECIFICATIONS	3
SAFETY SUMMARY	4
INTRODUCTION	5, 6
INSTALLATION.....	7, 8, 9, 10
TESTING THE REMOTE OPERATION.....	11
AIR PURGE	12
WARRANTY AND CUSTOMER SERVICE.....	12
STAINLESS STEEL CABLE REPLACEMENT	13, 14
PROBE OPTIONS	15, 16
LIMITING STAINLESS STEEL CABLE	17
MOUNTING OPTIONS.....	18
MOUNTING TEMPLATES.....	19, 20
SUREDROP ASSEMBLY INSTRUCTIONS.....	21
DECLARATION OF CONFORMITY	22

SPECIFICATIONS

SMARTBOB SPECIFICATIONS

	Power Requirements:.....	115 VAC Models: 115 VAC 60 Hz 230 VAC Models: 230 VAC 50/60Hz
	Power Consumption:.....	25 VA Continuous 69 VA Intermittent
	Current Draw (RMS):.....	@115 VAC: 0.22 A Continuous 0.6 A Intermittent @230 VAC: 0.12A Continuous 0.26 A Intermittent
	Fuse Size:.....	115 VAC Model: 1.0 Amp 250 V Time Delay TR5 style 230 VAC Model: 0.5 Amp 250 V Time Delay TR5 style
	Temperature Ratings:	
	CSA Rated Temperature:.....	32° F to +104°F (0°C to +40°C)
	Operating Temperature:.....	-40°F to +185°F (-40°C to +85°C)
	Maximum Internal Vessel Temperature:	
	Standard Unit with Nylon Jacketed Cable.....	Up to 225°F (107°C)
	With High Temperature Option:.....	Up to 500°F (260°C)
	Super High Temperature Option:.....	Up to 1000°F (538°C)
	Approvals:.....	CSA C/USA Class II, Division I, Groups E, F, & G CE Mark as described in Document of Conformity
	Measurement Range:.....	Up to 180 ft.
	Accuracy:.....	± 0.25% distance measurement accuracy
	Repeatability:.....	0.1 ft (0.03m)
	Resolution:.....	0.15 inch (0.4 cm)
	Communication:.....	RS-485 Half Duplex
	Wiring Distance:.....	4000 ft. (1220m)
	Enclosure Type:.....	Nema 4X, 5, 9 & 12
	Mounting:.....	3"- 8" NPT Floor Flange
	Conduit Entry:.....	3/4" NPT
	Weight:.....	25 lb.
	Width:.....	15-3/4"
	Height:.....	14-3/4"
	Depth:.....	7-1/2"
	Air Purge Entry:.....	1/4" NPT
	Cable:.....	316 Stainless Steel 0.063" Diameter Nylon Coated

SAFETY

SAFETY SUMMARY

Review the following safety precautions to avoid injury and prevent damage to the equipment.

The product should be installed, commissioned, and maintained by qualified and authorized personnel only.

Install according to installation instructions and comply with all National and Local codes.

Use electrical wire that is sized and rated for the maximum voltage and current of the application.

Properly ground the enclosure to an adequate earth ground.

Observe all terminal and relay contact ratings as called out on the nameplate and in the installation manual.

Ensure that the enclosure cover is in place and secured tightly during normal operation.

If this product is used in a manner not specified by the manufacturer, the safety protection could be compromised.

Safety Terms and Symbols



WARNING: Warning statements identify conditions or practices that could result in injury or loss of life. Risk of electrical shock.



CAUTION: Caution statements identify conditions or practices that could result in damage to this product or other property.



Safety Precaution

Whenever personnel are going to enter a vessel that has a SmartBob mounted on it, the power to the SmartBob should be turned off. The SmartBob lowers a 2 pound weight (Bob) of either metal or plastic material at a rate of approximately 1 to 2 feet per second when it is taking a measurement. The Bob impacting personnel while it is descending could possibly result in injury. Turning off the power to the SmartBob will disable the Bob from dropping.

1.0 INTRODUCTION

The BinMaster SmartBob SBR II is a remote on demand level measurement sensing unit. It is designed to work in conjunction with a Personal Computer running a Windows Operating System, a BinMaster C-100 console, an MUCM communications module, or a BinMaster RSU (Remote Start Unit). In operation, the SBR II lowers a weighted Bob to the surface of the product, measuring the distance. A microcontroller counts the pulses from an encoder. Slack in the cable is detected when the Bob reaches the surface, causing the motor to reverse and retract the Bob. The retract distance is also measured for diagnostic purposes to assure that the Bob fully retracts.

General system diagrams showing use with a personal computer, C-100 console, and an RSU controller are illustrated in Figures 1a through 1c. IMS and eBob programs are versions of Windows software for a PC for controlling the SBR II. IMS software will run on Windows 95, 98, NT, 2000, and XP. There are versions of eBob software for operation on Windows XP Pro, Vista, and Windows 7. Check the specific requirements for each version of software. The IMS and eBob software provides current inventory, extended inventory, measurement scheduling, vendor managed inventory, and site status via fax or email. eBob can also provide for Internet and intranet measurement capabilities. The C-100 is a stand-alone console that can control and display measurements of up to 120 vessels. The RSU is a single bob controller and provides 4-20 mA output for interfacing with other control systems. The IMS software and RSU operates in Protocol B. eBob 5 and the MUCM operate in Protocol A only. The C-100 console and eBob 5 can operate in either Protocol A or Protocol B. (See paragraph 2.7 for Protocol settings.)

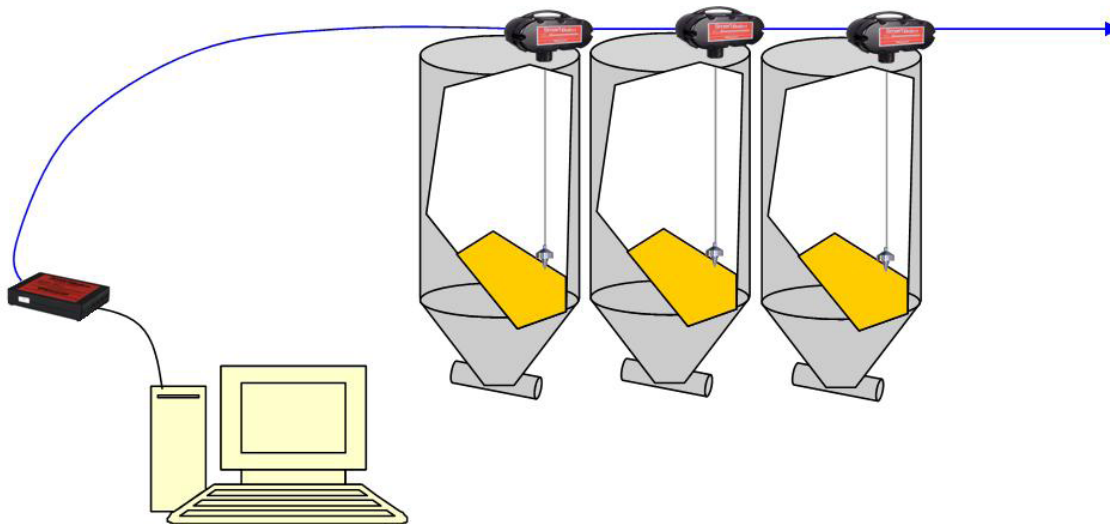

Figure 1a

Figure 1b
Console Driven SmartBob System

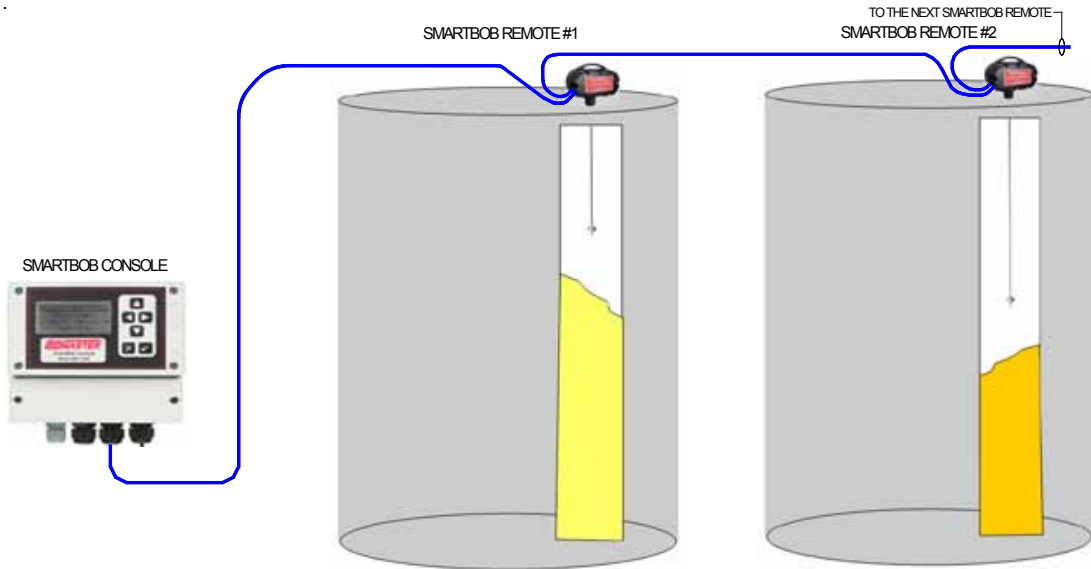
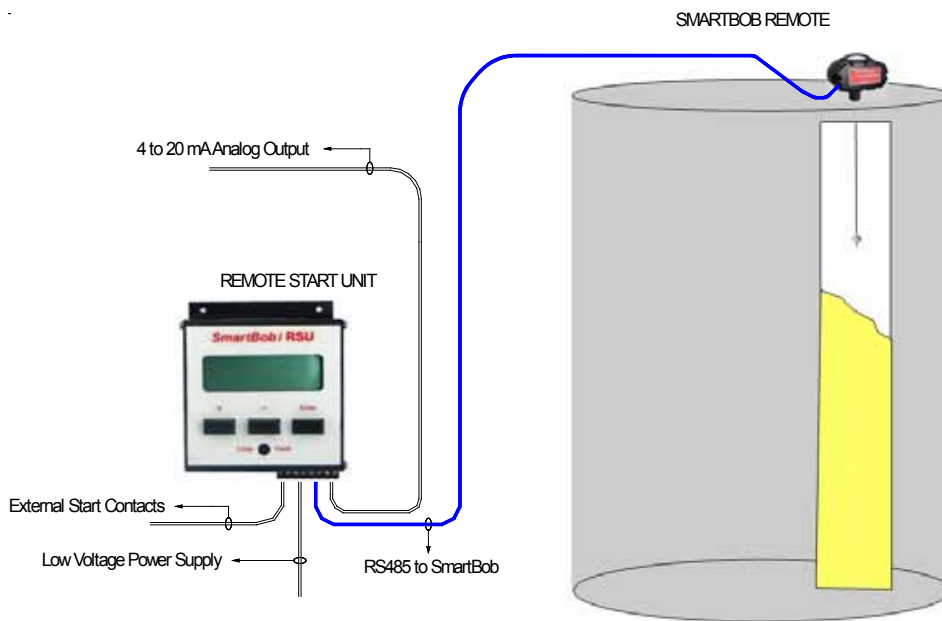

Figure 1c
RSU Controlled System



SBR II SMARTBOB REMOTE UNIT

BINMASTER

2.0 INSTALLATION

2.1 LOCATION AND MOUNTING

The SmartBob remote unit is mounted on the top of the storage vessel using a 3 inch NPT coupling. If a 3 inch NPT floor flange is used, it must be on a flat, level surface to provide a vertical mount for the unit. For measuring dry solids which involve an angle of repose, it is recommended that the unit be mounted $1/6$ th of the vessel diameter in from the side, see Figure 2. A mounting flange template is provided on last page of this manual for a standard 3 inch NPT floor flange with a 5-1/8 inch bolt circle.

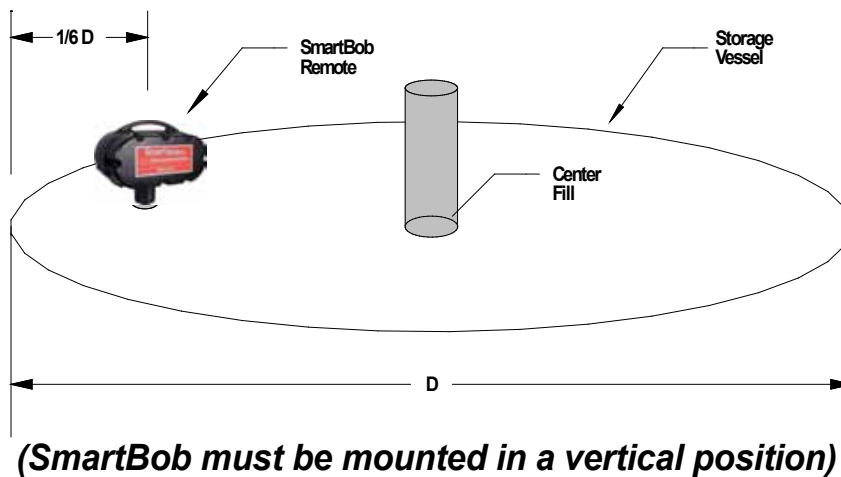

Figure 2

2.2 RS-485 NETWORK WIRING

The SBR II remotes are connected by a shielded twisted pair cable referred to as an RS-485 network. This cable must run from one remote to the next connecting each remote in a daisy-chained fashion with **no stub branch runs**. All connections should be made at the terminals on the circuit board, see Figure 4. Be careful to **maintain the proper wiring polarity** at each terminal connection. The shield on the RS-485 cable must be connected to the **shield** terminal on the circuit board, not to the enclosure ground.

2.3 NETWORK TERMINATION

On each SBR II remote unit, SBC, RSU, and RS-485 interface module, there is a network termination switch, labeled NTR. The two units on each end of the RS-485 daisy chained network **must** have their NTR switch placed in the "ON" position. All other units on the network must have this switch set to the "OFF" position. See Figure 4.

NOTE: *When installing the SBR II in locations where moisture or moist air could enter the electrical compartment through the electrical conduit, the conduit openings should be adequately sealed with a duct seal compound.*

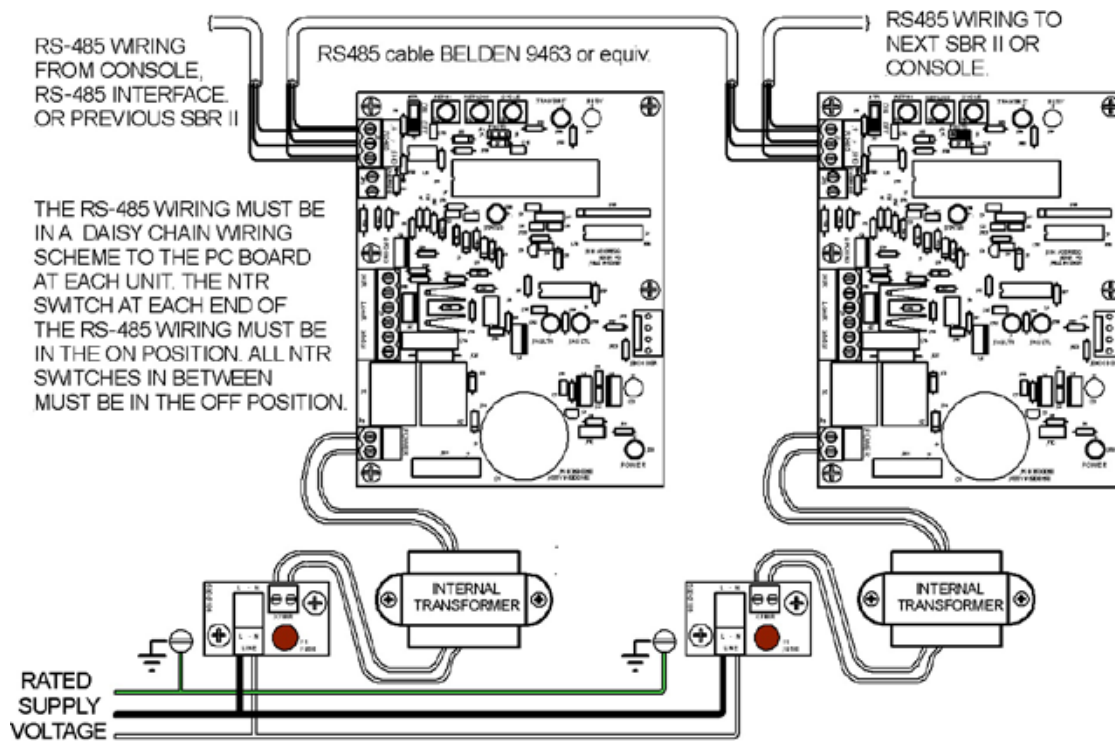

Figure 4



2.4 POWER WIRING

All wiring should be installed according to local and/or national codes. A disconnecting means should be provided to disconnect incoming power to this device. **All field wiring should have a temperature rating of at least 85 degrees C.** Refer to Figures 4 & 5 for the connection of the power wiring. The AC input power connects to the 2 pole terminal block located on the motor mount bracket. The neutral wire should be connected to the terminal on the right and the "LINE" conductor connected to the terminal on the left. The terminal on the left wires through the fuse to the transformer.

A green ground screw is provided in the SmartBob enclosure for electrically grounding the unit. A good electrical ground must be connected to the SBR II for safety and to bleed off any static electrical charges that might build up in the SBR II. It is recommended that both the power and the RS-485 communication cable be run in metal conduit.

2.5 SETTING THE ADDRESS

The BinMaster IMS software can accommodate up to 30 SBR II remote units with the standard RS-485 interface. The eBob software can accommodate up to 100 SBR II remote units. The C-100 console can accommodate up to 120 SBR II remote units. Therefore a unique address must be set for each remote. Refer to Figure 4 and Table 1 regarding setting the address each for remote. This figure and table are also located on the inside cover of the SBR II enclosure. The RSU console only operates with one SmartBob remote. The address of a remote unit operating with an RSU must be set to #1.

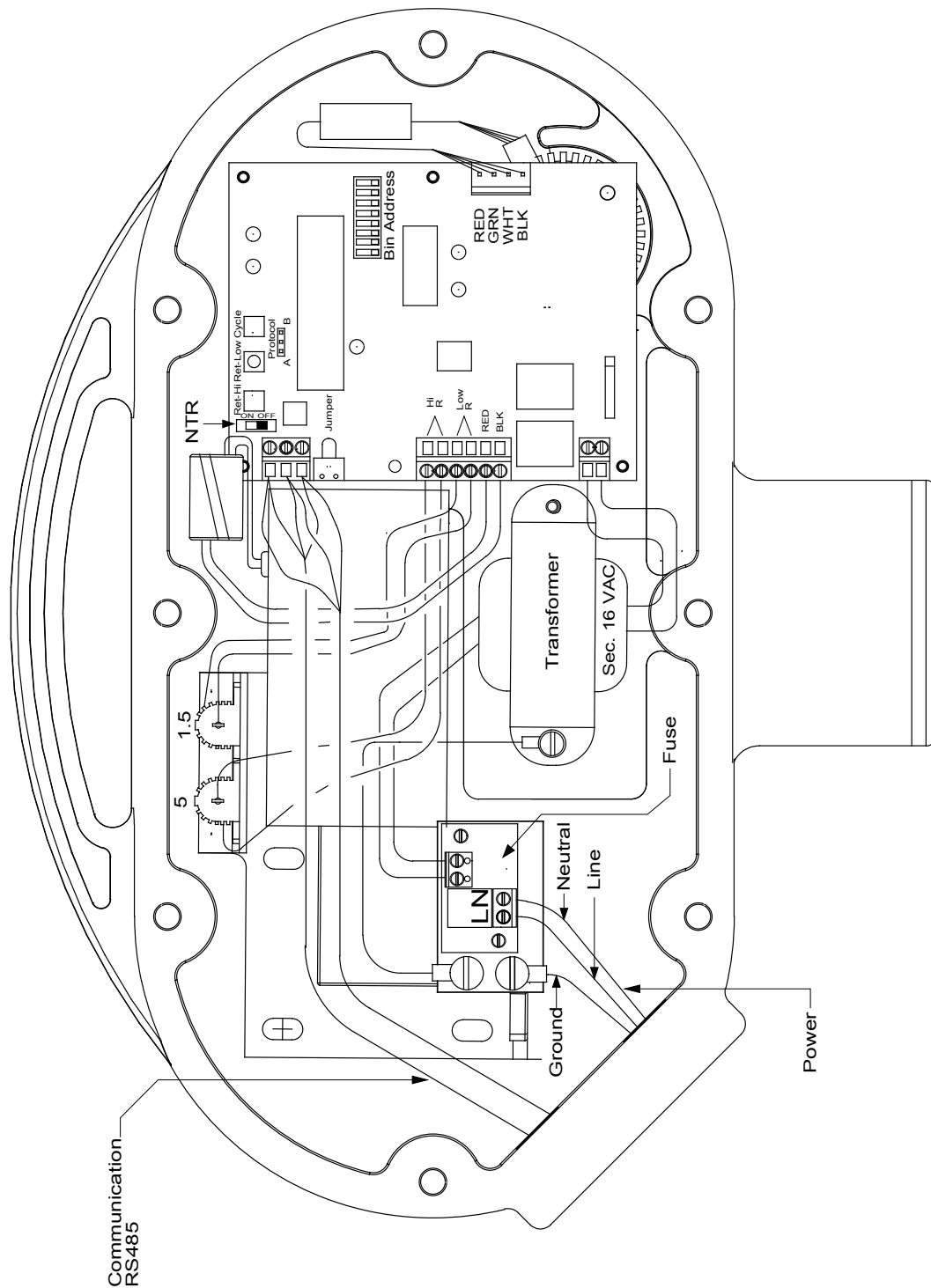

SBR II Wiring Diagram
Figure 5

TABLE 1 - BIN ADDRESS DIP SWITCH SETTINGS

BIN ADDRESS	DIP SWITCH SETTINGS								BIN ADDRESS	DIP SWITCH SETTINGS							
	1	2	3	4	5	6	7	8		1	2	3	4	5	6	7	8
1	ON	OFF	OFF	OFF	OFF	OFF	OFF	OFF	65	ON	OFF	OFF	OFF	OFF	OFF	ON	OFF
2	OFF	ON	OFF	OFF	OFF	OFF	OFF	OFF	66	OFF	ON	OFF	OFF	OFF	OFF	ON	OFF
3	ON	ON	OFF	OFF	OFF	OFF	OFF	OFF	67	ON	ON	OFF	OFF	OFF	ON	OFF	OFF
4	OFF	OFF	ON	OFF	OFF	OFF	OFF	OFF	68	OFF	OFF	ON	OFF	OFF	OFF	ON	OFF
5	ON	OFF	ON	OFF	OFF	OFF	OFF	OFF	69	ON	OFF	ON	OFF	OFF	OFF	ON	OFF
6	OFF	ON	ON	OFF	OFF	OFF	OFF	OFF	70	OFF	ON	ON	OFF	OFF	OFF	ON	OFF
7	ON	ON	ON	OFF	OFF	OFF	OFF	OFF	71	ON	ON	ON	OFF	OFF	OFF	ON	OFF
8	OFF	OFF	OFF	ON	OFF	OFF	OFF	OFF	72	OFF	OFF	OFF	ON	OFF	OFF	ON	OFF
9	ON	OFF	OFF	ON	OFF	OFF	OFF	OFF	73	ON	OFF	OFF	ON	OFF	OFF	ON	OFF
10	OFF	ON	OFF	ON	OFF	OFF	OFF	OFF	74	OFF	ON	OFF	ON	OFF	OFF	ON	OFF
11	ON	ON	OFF	ON	OFF	OFF	OFF	OFF	75	ON	ON	OFF	ON	OFF	OFF	ON	OFF
12	OFF	OFF	ON	ON	OFF	OFF	OFF	OFF	76	OFF	OFF	ON	ON	OFF	OFF	ON	OFF
13	ON	OFF	ON	ON	OFF	OFF	OFF	OFF	77	ON	OFF	ON	ON	OFF	OFF	ON	OFF
14	OFF	ON	ON	ON	OFF	OFF	OFF	OFF	78	OFF	ON	ON	ON	OFF	OFF	ON	OFF
15	ON	ON	ON	ON	OFF	OFF	OFF	OFF	79	ON	ON	ON	ON	OFF	OFF	ON	OFF
16	OFF	OFF	OFF	OFF	ON	OFF	OFF	OFF	80	OFF	OFF	OFF	OFF	ON	OFF	ON	OFF
17	ON	OFF	OFF	OFF	ON	OFF	OFF	OFF	81	ON	OFF	OFF	OFF	ON	OFF	ON	OFF
18	OFF	ON	OFF	OFF	ON	OFF	OFF	OFF	82	OFF	ON	OFF	OFF	ON	OFF	ON	OFF
19	ON	ON	OFF	OFF	ON	OFF	OFF	OFF	83	ON	ON	OFF	OFF	ON	OFF	ON	OFF
20	OFF	OFF	ON	OFF	ON	OFF	OFF	OFF	84	OFF	OFF	ON	OFF	ON	OFF	ON	OFF
21	ON	OFF	ON	OFF	ON	OFF	OFF	OFF	85	ON	OFF	ON	OFF	ON	OFF	ON	OFF
22	OFF	ON	ON	OFF	ON	OFF	OFF	OFF	86	OFF	ON	ON	OFF	ON	OFF	ON	OFF
23	ON	ON	ON	OFF	ON	OFF	OFF	OFF	87	ON	ON	ON	OFF	ON	OFF	ON	OFF
24	OFF	OFF	OFF	ON	ON	OFF	OFF	OFF	88	OFF	OFF	OFF	ON	ON	OFF	ON	OFF
25	ON	OFF	OFF	ON	ON	OFF	OFF	OFF	89	ON	OFF	OFF	ON	ON	OFF	ON	OFF
26	OFF	ON	OFF	ON	ON	OFF	OFF	OFF	90	OFF	ON	OFF	ON	ON	OFF	ON	OFF
27	ON	ON	OFF	ON	ON	OFF	OFF	OFF	91	ON	ON	OFF	ON	ON	OFF	ON	OFF
28	OFF	OFF	ON	ON	ON	OFF	OFF	OFF	92	OFF	OFF	ON	ON	ON	OFF	ON	OFF
29	ON	OFF	ON	ON	ON	OFF	OFF	OFF	93	ON	OFF	ON	ON	ON	OFF	ON	OFF
30	OFF	ON	ON	ON	ON	OFF	OFF	OFF	94	OFF	ON	ON	ON	ON	OFF	ON	OFF
31	ON	ON	ON	ON	ON	OFF	OFF	OFF	95	ON	ON	ON	ON	ON	OFF	ON	OFF
32	OFF	OFF	OFF	OFF	OFF	ON	OFF	OFF	96	OFF	OFF	OFF	OFF	OFF	ON	ON	OFF
33	ON	OFF	OFF	OFF	OFF	ON	OFF	OFF	97	ON	OFF	OFF	OFF	OFF	ON	ON	OFF
34	OFF	ON	OFF	OFF	OFF	ON	OFF	OFF	98	OFF	ON	OFF	OFF	OFF	ON	ON	OFF
35	ON	ON	OFF	OFF	OFF	ON	OFF	OFF	99	ON	ON	OFF	OFF	OFF	ON	ON	OFF
36	OFF	OFF	ON	OFF	OFF	ON	OFF	OFF	100	OFF	OFF	ON	OFF	OFF	ON	ON	OFF
37	ON	OFF	ON	OFF	OFF	ON	OFF	OFF	101	ON	OFF	ON	OFF	OFF	ON	ON	OFF
38	OFF	ON	ON	OFF	OFF	ON	OFF	OFF	102	OFF	ON	ON	OFF	OFF	ON	ON	OFF
39	ON	ON	ON	OFF	OFF	ON	OFF	OFF	103	ON	ON	ON	OFF	OFF	ON	ON	OFF
40	OFF	OFF	OFF	ON	OFF	ON	OFF	OFF	104	OFF	OFF	OFF	ON	OFF	ON	ON	OFF
41	ON	OFF	OFF	ON	OFF	ON	OFF	OFF	105	ON	OFF	OFF	ON	OFF	ON	ON	OFF
42	OFF	ON	OFF	ON	OFF	ON	OFF	OFF	106	OFF	ON	OFF	ON	OFF	ON	ON	OFF
43	ON	ON	OFF	ON	OFF	ON	OFF	OFF	107	ON	ON	OFF	ON	OFF	ON	ON	OFF
44	OFF	OFF	ON	ON	OFF	ON	OFF	OFF	108	OFF	OFF	ON	ON	OFF	ON	ON	OFF
45	ON	OFF	ON	ON	OFF	ON	OFF	OFF	109	ON	OFF	ON	ON	OFF	ON	ON	OFF
46	OFF	ON	ON	ON	OFF	ON	OFF	OFF	110	OFF	ON	ON	ON	OFF	ON	ON	OFF
47	ON	ON	ON	ON	OFF	ON	OFF	OFF	111	ON	ON	ON	ON	OFF	ON	ON	OFF
48	OFF	OFF	OFF	OFF	ON	ON	OFF	OFF	112	OFF	OFF	OFF	OFF	ON	ON	ON	OFF
49	ON	OFF	OFF	OFF	ON	ON	OFF	OFF	113	ON	OFF	OFF	OFF	ON	ON	ON	OFF
50	OFF	ON	OFF	OFF	ON	ON	OFF	OFF	114	OFF	ON	OFF	OFF	ON	ON	ON	OFF
51	ON	ON	OFF	OFF	ON	ON	OFF	OFF	115	ON	ON	OFF	OFF	ON	ON	ON	OFF
52	OFF	OFF	ON	OFF	ON	ON	OFF	OFF	116	OFF	OFF	ON	OFF	ON	ON	ON	OFF
53	ON	OFF	ON	OFF	ON	ON	OFF	OFF	117	ON	OFF	ON	OFF	ON	ON	ON	OFF
54	OFF	ON	ON	OFF	ON	ON	OFF	OFF	118	OFF	ON	ON	OFF	ON	ON	ON	OFF
55	ON	ON	ON	OFF	ON	ON	OFF	OFF	119	ON	ON	ON	OFF	ON	ON	ON	OFF
56	OFF	OFF	OFF	ON	ON	ON	OFF	OFF	120	OFF	OFF	OFF	ON	ON	ON	ON	OFF
57	ON	OFF	OFF	ON	ON	ON	OFF	OFF	121	ON	OFF	OFF	ON	ON	ON	ON	OFF
58	OFF	ON	OFF	ON	ON	ON	OFF	OFF	122	OFF	ON	OFF	ON	ON	ON	ON	OFF
59	ON	ON	OFF	ON	ON	ON	OFF	OFF	123	ON	ON	OFF	ON	ON	ON	ON	OFF
60	OFF	OFF	ON	ON	ON	ON	OFF	OFF	124	OFF	OFF	ON	ON	ON	ON	ON	OFF
61	ON	OFF	ON	ON	ON	ON	OFF	OFF	125	ON	OFF	ON	ON	ON	ON	ON	OFF
62	OFF	ON	ON	ON	ON	ON	OFF	OFF	126	OFF	ON	ON	ON	ON	ON	ON	OFF
63	ON	ON	ON	ON	ON	ON	OFF	OFF	127	ON	ON	ON	ON	ON	ON	ON	OFF
64	OFF	OFF	OFF	OFF	OFF	OFF	ON	OFF	128	OFF	OFF	OFF	OFF	OFF	OFF	OFF	ON

SBR II SMARTBOB REMOTE UNIT



2.4 EXTERNAL OVERRIDE

This feature can be used to prohibit measurements during a vessel filling cycle. The IMS software will notify the user that a measurement cannot be taken while a filling operation is in progress. Located on the SmartBob circuit board in the upper left corner (just below the RS-485 terminals), is the terminal block labeled **VERRIDE**. A connection must exist across these terminals for normal operation of the remote unit, see Figure 6. A contact on an external relay can be used to disable the remote unit during a fill cycle to prevent burying the Bob. The use of this feature is optional. If not used, leave the factory installed jumper in terminal block.

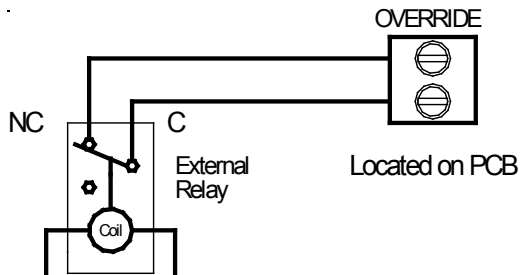

Figure 6

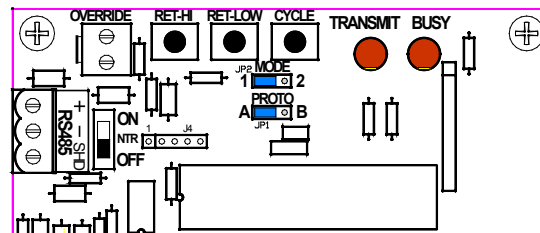

Figure 7

2.7 PROTOCOL SETTING

The SBR II has a Protocol jumper that can be set in two different positions depending on what software or console the SBR II is controlled from, see Figure 7. This jumper should be in the **A** position if the SBR II is controlled from eBob 4 software or an MUCM. The jumper should be in the **B** position if the SBR II is controlled from the RSU consoles or the IMS software. The C-100 or eBob 5 software can be set to run in either Protocol **A** or **B**.

3.0 TESTING THE REMOTE OPERATION

3.1 MANUAL OPERATION FROM REMOTE UNIT

Once the SmartBob Remote is installed and wired properly it can be manually cycled to verify proper operation. To perform the manual test:

- Open the electrical side of the remote unit.
- Press the **CYCLE** button located at the top of the printed circuit board. The unit will immediately lower the probe Bob to the surface and return.
- Replace the electrical side cover.

3.2 TROUBLESHOOTING

If the remote fails to cycle, verify that input power is present at the terminal block and that the **POWER LED** located on the circuit board (in lower right corner), is lit. This LED should be lit whenever the power is present at the board terminals. If the unit still does not operate, consult the factory at 800-278-4241.

4.0 AIR PURGE SYSTEM

Located on the lower right side of each SmartBob remote unit is a 1/4" NPT air fitting. This fitting can be used to connect an external source of dry, clean air or non-combustible gas to the remote housing. By adding pressure to the remote housing that is slightly greater than that in the vessel, material and dust from the vessel is prevented from entering the unit. The external pressure should be one (1) psi greater than the ambient pressure in the storage vessel and should be free from moisture and other contaminants.

5.0 WARRANTY AND CUSTOMER SERVICE

5.1 LIMITED WARRANTY

The manufacturer warrants this equipment for two (2) years according to the following terms:

1. This warranty extends to the original purchaser only and commences on the date of original purchase. The original purchaser must mail to the manufacturer the "Warranty Registration" card to confirm the equipment purchase. Failure to do so may void the warranty.
2. The manufacturer will repair or replace any part of this equipment found to be defective, provided such part is delivered prepaid to the factory. Manufacturer's obligation is limited to the cost of material and labor to repair or replace and does not include transportation expenses.
3. This warranty shall not apply to any product that has, in our judgement, been tampered with, altered, subjected to misuse, neglect or accident. In addition, the warranty does not extend to repairs made necessary by normal wear.
4. This warranty is in lieu of all other warranties, expressed or implied.

5.2 CUSTOMER SERVICE

BinMaster offers a toll-free Customer Service phone number, **800-278-4241**. You may call the Customer Service Department for technical and application assistance Monday through Friday from 8:00 AM to 5:00 PM Central Time. International customers call us at **(402) 434-9102** or reach us via **Fax** at **(402) 434-9133**. E-mail questions to "info@binmaster.com".

Note: This equipment has been tested and found to comply with the limits for a Class A digital device, pursuant to part 15 of the FCC Rules. These limits are designed to provide reasonable protection against harmful interference when the equipment is operated in a commercial environment. This equipment generates, uses, and can radiate radio frequency energy and if not installed and used in accordance with the instruction manual, may cause harmful interference in which case the user will be required to correct the interference at their own expense.

The logo for BinMaster, featuring the word "BINMASTER" in a bold, sans-serif font. The letters "B", "I", and "N" are stacked vertically, while "M", "A", "S", "T", "E", "R" are arranged horizontally to the right. A registered trademark symbol (®) is located to the upper right of the word.

Cable Replacement Instructions

Before Starting

Disconnect the power source. Remove the flat cover on the back of the remote housing.

Cable Replacement

1. Remove the cable from the supply pulley by pressing the "CYCLE" button on the top of the PC board. Keeping the cable taut, pull on the cable as the cable spools off the pulley. When the line is completely pulled out, the motor will reverse and try to rewind the cable. Hold the cable tight so it cannot rewind. The motor should now be shut off. Discard old cable.
2. Attached to the end of the new cable is a terminal crimp ring. Attach this crimp ring to the supply pulley flange as shown in the illustration.
3. To rewind cable onto the supply pulley refer to "**Loading the Supply Pulley**" on page 14.
4. After loading the supply pulley, skip to "**Threading the Cable**".

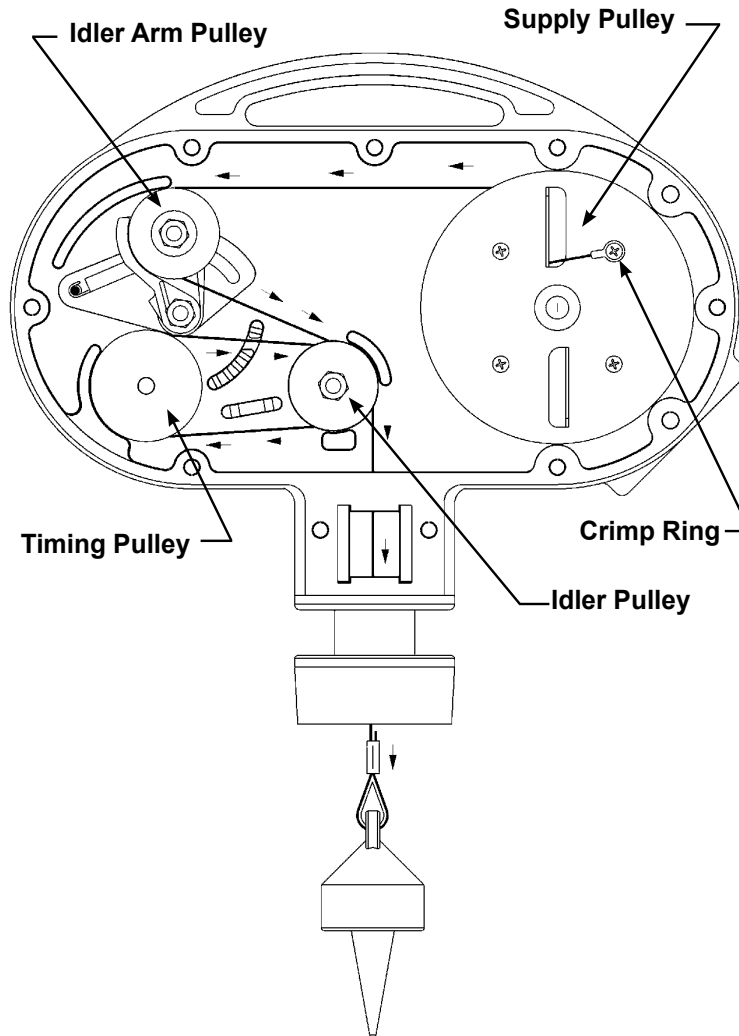

Kit Replacement

1. Loosen the 1/4" set screw located on the hub of the supply pulley, then remove the supply pulley assembly.
2. Remove and discard the old supply pulley and cable.
3. Assemble the new supply pulley replacement kit.
4. Skip to "**Threading The Cable**".

Threading The Cable

1. Thread the cable over the top of the idler arm pulley, over the top of the front groove of the idler pulley, under the timing pulley, then over the top of the back groove of the idler pulley as shown in the illustration. Then thread the cable down through the brushes and threaded mount assembly. Referring to the "**Suredrop Cable Release System**" on page 20, attach the Suredrop assembly and weighted bob.

NOTE: At this point you should refer to the attached manual instruction sheet “Limiting Stainless Steel Cable”. Follow steps 2 through 6.

Loading The Supply Pulley

1. Reconnect the power source.
2. If loading the supply pulley is necessary, pull the cable taut. Load the supply pulley by pressing the “RET-HI” button located on the circuit board. Pressing this button will start the supply pulley turning in a clockwise direction, with the cable winding over the top. Keep the cable taut until the pulley is full. When the supply pulley is full, release the “RET-HI” button.
3. Replace the cable wiper brushes and reattach the cover.

Probe Options

B1 & B2

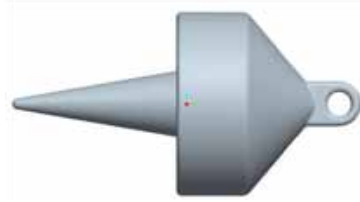

This stainless steel Bob is designed for granular materials from 20 lb. per cubic foot and greater. This Bob is shipped standard with every SmartBob remote. A 416 SS magnetic version is **Order Code B2**.

B3

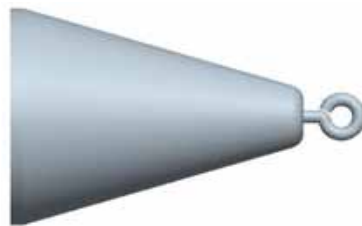

This Bob is a hollow inverted 4-inch cone made of stainless steel and is designed for bulk products with a density from 5 lb. to 20 lb. per cubic foot. This Bob should **not** be used in liquids.

B4

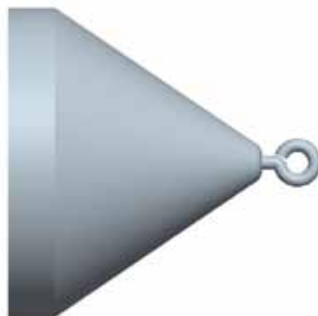

This Bob is a hollow inverted 6-inch cone made of stainless steel and is designed for bulk products with a density from 1.5 lb. to 20 lb. per cubic foot. This Bob may also be used in liquid applications.

Probe Options

B5 & B6



This Bob is designed for granular material with a density of 20 lb. per cubic foot and greater. This Bob is a digestible bottle that is filled with 32 oz. of paraffin wax. The digestible bottle is made from an engineering plastic which will not damage the material handling auger in the unlikely event that the Bob should become separated from the unit. **Order code B6** is an empty bottle option of this Bob which is to be filled in the field to a weight of about 32 ounces.

B9



This Bob is a 6-inch stainless steel hollow sphere and is designed for use in liquids, slurries, and for light powder applications.

Limiting Stainless Steel Cable SBR II

It is important to limit the length of cable on the SBR remote, so that the bob is not lowered into an airlock, screw conveyor, or any other area that the bob might become trapped in. The SBR remote is shipped with 90' of cable unless otherwise specified. Disregard these instructions if the unit was ordered with the exact amount of cable necessary for your vessel. This procedure for limiting the cable should be done **before** the unit is installed:

1. Remove the cable from the supply pulley by pressing the "CYCLE" button on the top of the PC board. Keeping the cable taut, pull on the cable as the cable spools off the pulley. When the line is completely pulled out, the motor will reverse and try to rewind the cable. Hold the cable tight so it cannot rewind. The motor should now be shut off.
2. From the throat or pipe extension of the SBR II, measure the height of your vessel or the maximum distance you want the bob to travel into your vessel, then add 48" to that length.
3. Cut the stainless steel cable at this distance (vessel height + 48").
4. Refer to "**SureDrop Cable Release System**" assembly instructions on page 20.
5. Thread the stainless steel cable through the Suredrop, thimble and bob as shown.
6. Tighten and crimp the noose around the thimble. Locate and crimp the round crimp as shown.
7. Test crimp by pulling on the cable and bob.
8. Rewind the cable onto the supply pulley or lower the cable and bob into the vessel. To rewind onto the supply pulley: Pull the cable taut. Load the supply by pressing (and hold) the "RET-HI" button located on the circuit board. Pressing this button will start the supply pulley turning in a clockwise direction, with the cable winding over the top.

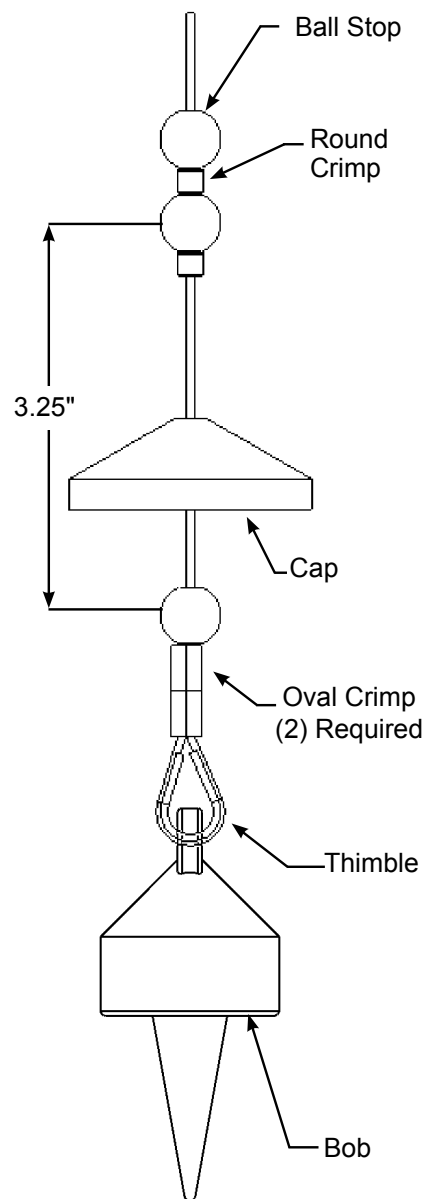

SBR II SMARTBOB REMOTE UNIT

BINMASTER

Mounting Options

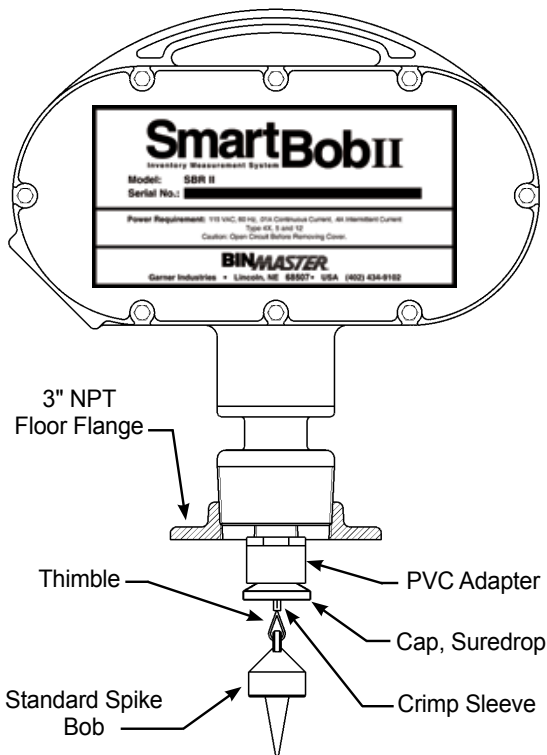

Standard Flange Mount

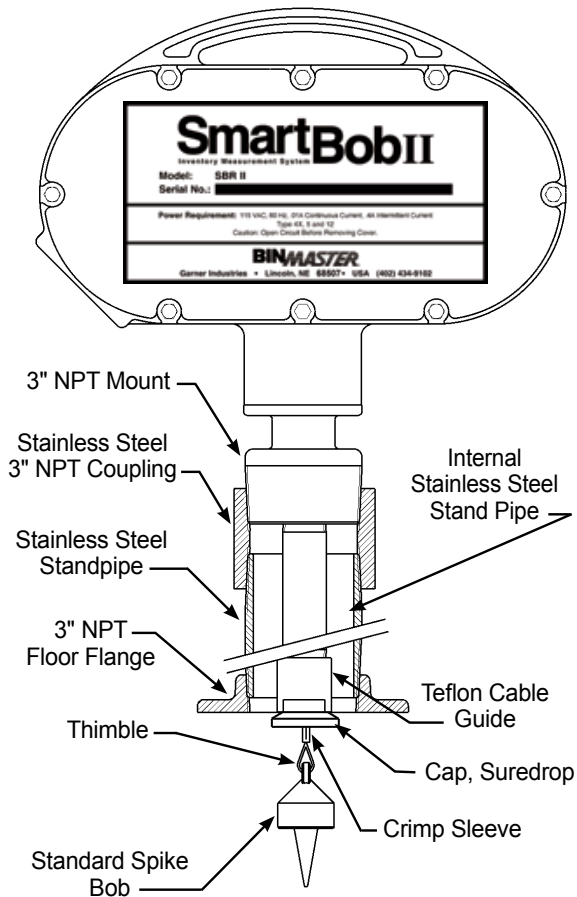

High Temperature Mount

SBR II SMARTBOB REMOTE UNIT

BINMASTER

SMARTBOB REMOTE MOUNTING TEMPLATE
5 inch floor flange

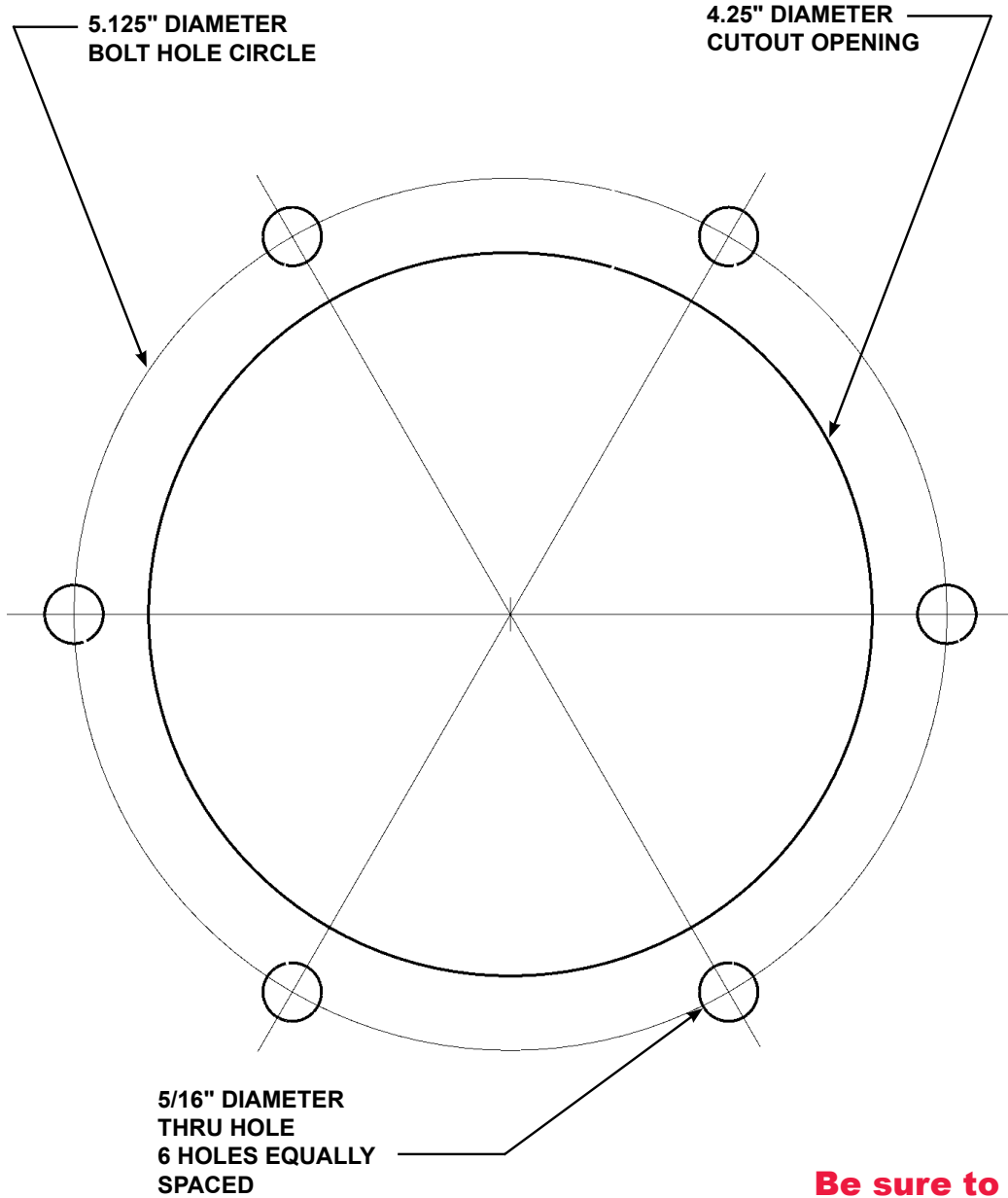

**Be sure to
print to scale
if used as
a template**

SBR II SMARTBOB REMOTE UNIT

BINMASTER



SMARTBOB REMOTE MOUNTING TEMPLATE

7 inch custom mount

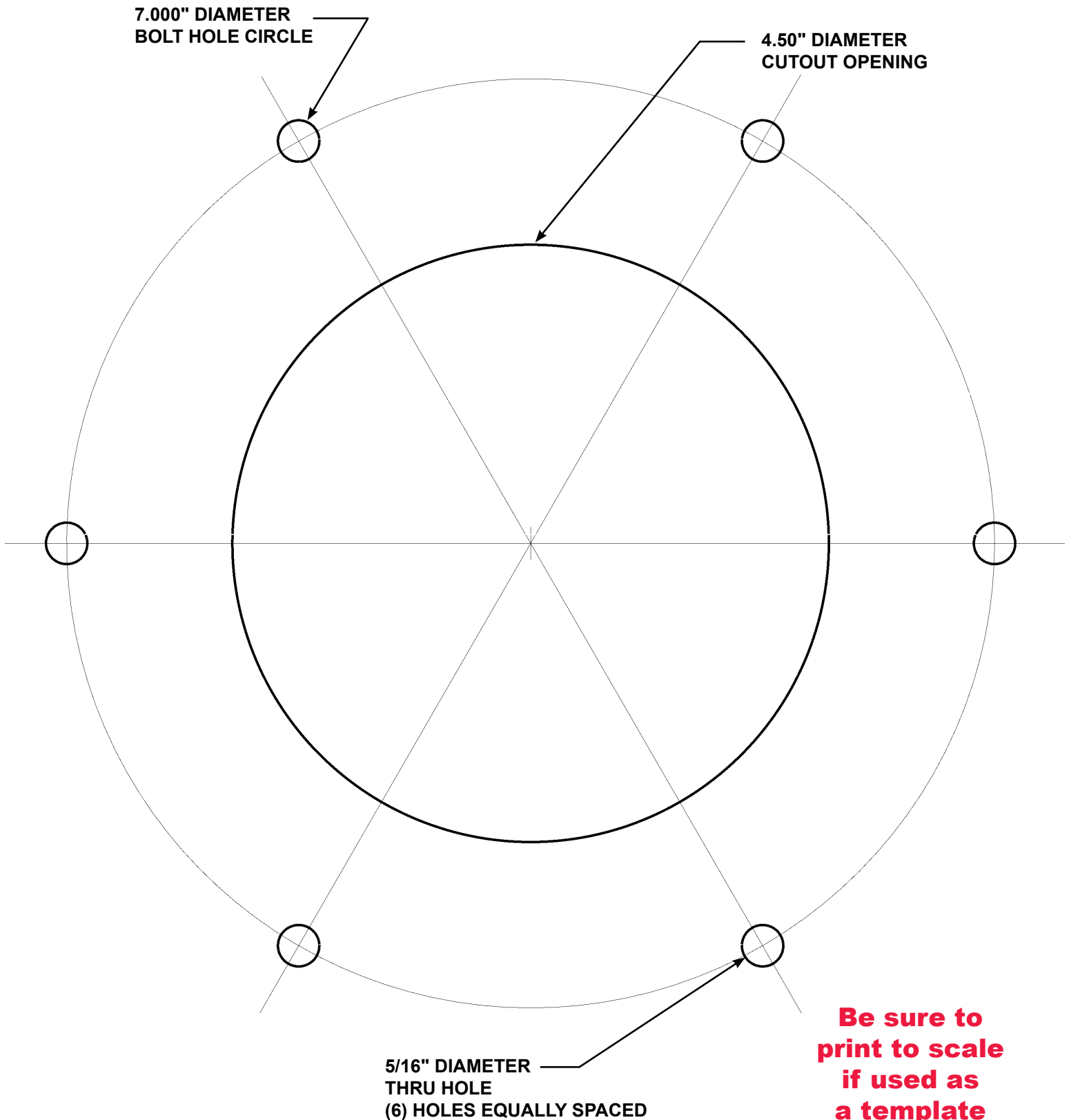



SureDrop Cable Release System Assembly Instructions

Assemble the SureDrop cable release system in the order shown in the figure below.

- 1) Ball Stop
- 2) Round Crimp
- 3) Ball Stop
- 4) Round Crimp
- 5) Cap
- 6) Ball Stop
- 7) Oval Crimp
- 8) Thimble
- 9) Cable

After all items are located as shown, compress the crimps in place. When compressing the crimps, be careful not to over tighten. Over tightening could cut and damage the cable.

